



AIR  
SPIRALO®

VENTILATION DUCTS & FITTINGS

**RSD**

## Rectangular polyester silencer

### Application

It is commonly accepted that 30dB(A) is the upper limit for noise pollution in housing but dynamic sound (rustle) and noise caused by air handling units, fans, diffusers or other components in a ventilation system can be higher than 30dB(A).

### Prevention

Air Spiralo manufactures a complete serie of circular and rectangular silencers with circular connections and bends, all with a very low aero-dynamic resistance and unrivalled sound attenuation.

### Unique features

- Highest possible sound attenuation combined with very low resistance
- Pressure loss circular silencer: same value as for standard duct with identical length
- Specially formed inner tube for highest sound attenuation
- Tested by an independent laboratory according to ISO 7235
- Innovative construction of inside and outside shell ensures no contactor noise
- Ideal aero-dynamics profile by the absence of corners and borders
- Low building height
- Openable or closed (standard) models
- Easy to clean with brushes, no sharp edges or dust pockets
- Standard insulation thickness 50 mm. Other thickness on request.
- A retaining fiber cloth prevents any particles entering the current of air
- KEN-LOK connections with rubber seal
- Air tightness class ATC2
- Sendzimir galvanized steel. Other lengths and/or material on request.



## Order code:

RSDP012.030.11K

RS = Rectangular silencer  
 D = Polyester  
 P = Perforated straight tube, F = Perforated formed tube  
 012 = Diameter  $\varnothing 125$  mm  
 030 = Length 300 mm, 060 = 600 mm, 100 = 1000 mm  
 11 = Closed model, 12 = Openable model  
 K = KEN-LOK rubber seal



## Dimensions RSD, closed model (11) / openable model (12)

RSD-type	Dimensions (mm)						Attenuation $\Delta L$ (dB) / Octaves (Hz)							
	$\varnothing d_1$	$l_1$	$l_{p1}$	$a_1$	$b_1$	$b_2$	63	125	250	500	1000	2000	4000	8000
RSDP010.030.11(12)K	100	300	48	262	152	75	8	10	13	20	23	18	16	13
RSDF010.060.11(12)K	100	600	48	262	152	75	15	19	20	29	37	40	30	21
RSDF010.100.11(12)K	100	1000	48	262	152	75	21	22	27	38	48	48	42	30
RSDP012.030.11(12)K	125	300	48	272	178	88	8	9	11	18	21	16	15	12
RSDF012.060.11(12)K	125	600	48	272	178	88	14	17	18	27	34	38	27	19
RSDF012.100.11(12)K	125	1000	48	272	178	88	16	18	24	35	45	47	39	27
RSDP015.030.11(12)K	150	300	48	292	212	105	8	8	9	17	19	15	13	10
RSDF015.060.11(12)K	150	600	48	292	212	105	13	16	16	24	31	36	25	16
RSDF015.100.11(12)K	150	1000	48	292	212	105	14	17	22	32	42	44	33	24
RSDP016.030.11(12)K	160	300	48	292	212	105	8	8	9	17	19	15	13	10
RSDF016.060.11(12)K	160	600	48	292	212	105	13	16	16	24	31	36	25	16
RSDF016.100.11(12)K	160	1000	48	292	212	105	14	17	22	32	42	44	33	24
RSDP018.030.11(12)K	180	300	48	373	255	127	7	7	8	14	16	13	10	8
RSDP018.060.11(12)K	180	600	48	373	255	127	13	14	15	23	29	32	23	14
RSDP018.100.11(12)K	180	1000	48	373	255	127	15	17	21	31	41	40	27	21
RSDP020.030.11(12)K	200	300	48	373	255	127	7	7	8	14	16	13	10	8
RSDF020.060.11(12)K	200	600	48	373	255	127	13	14	15	23	29	32	23	14
RSDF020.100.11(12)K	200	1000	48	373	255	127	15	17	21	31	41	40	27	21
RSDF025.060.11(12)K	250	600	58	442	302	150	12	13	15	21	27	26	18	11
RSDF025.100.11(12)K	250	1000	58	442	302	150	17	17	20	29	39	33	23	17
RSDF031.060.11(12)K	315	600	58	470	370	184	11	12	13	19	24	17	12	9
RSDF031.100.11(12)K	315	1000	58	470	370	184	16	14	18	27	34	23	19	15
RSDF040.060.11(12)K	400	600	58	532	452	225	10	11	12	17	21	14	11	7
RSDF040.100.11(12)K	400	1000	58	532	452	225	16	12	17	24	28	17	15	13
RSDP050.060.11(12)K	500	600	58	713	557	278	4	8	9	13	14	11	8	5
RSDP050.100.11(12)K	500	1000	58	713	557	278	8	10	14	17	19	13	10	8
RSDP063.060.11(12)K	630	600	58	864	687	343	3	6	7	10	11	8	7	4
RSDP063.100.11(12)K	630	1000	58	864	687	343	6	8	13	14	15	11	8	5

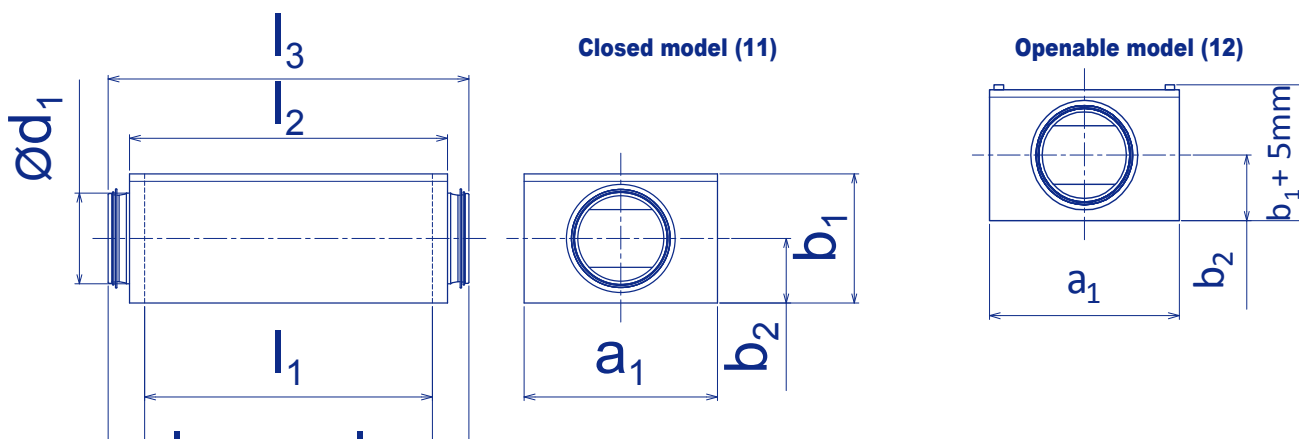

sales@airspiralo.com

For extra information and technical specifications, please visit [www.airspiralo.com](http://www.airspiralo.com); these data are leading

## Pressure loss (ISO 5167), RSDF (I<sub>1</sub>=600)

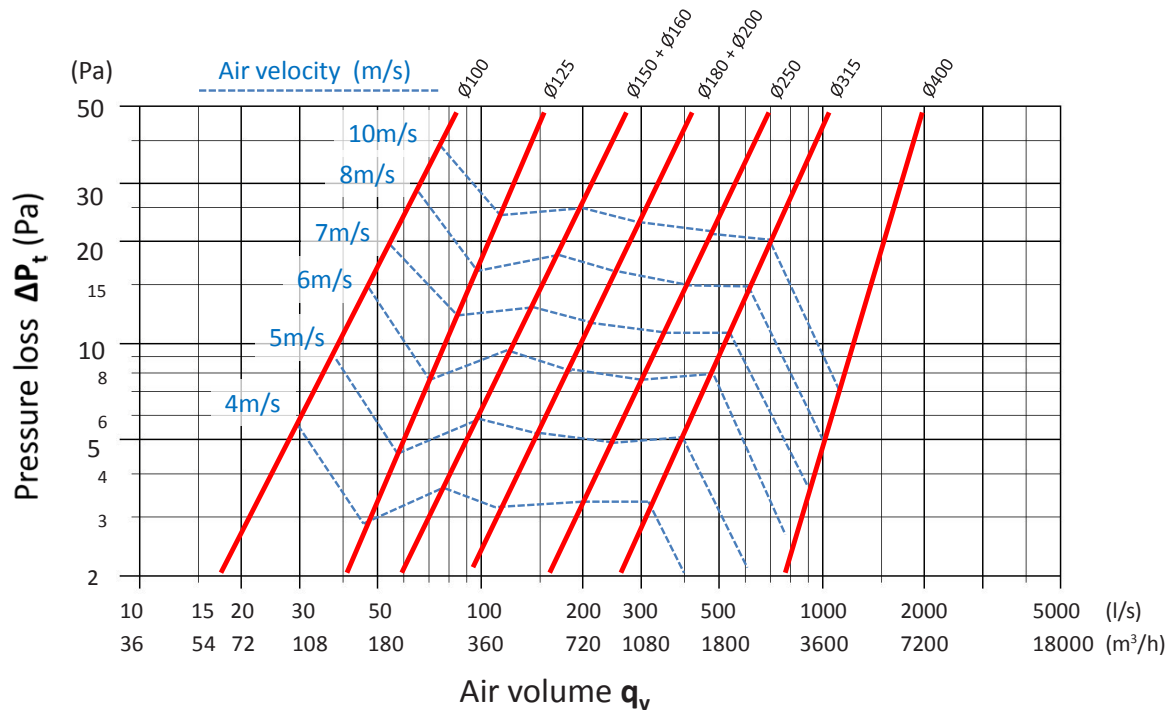

## Pressure loss (ISO 5167), RSDF (I<sub>1</sub>=1000)

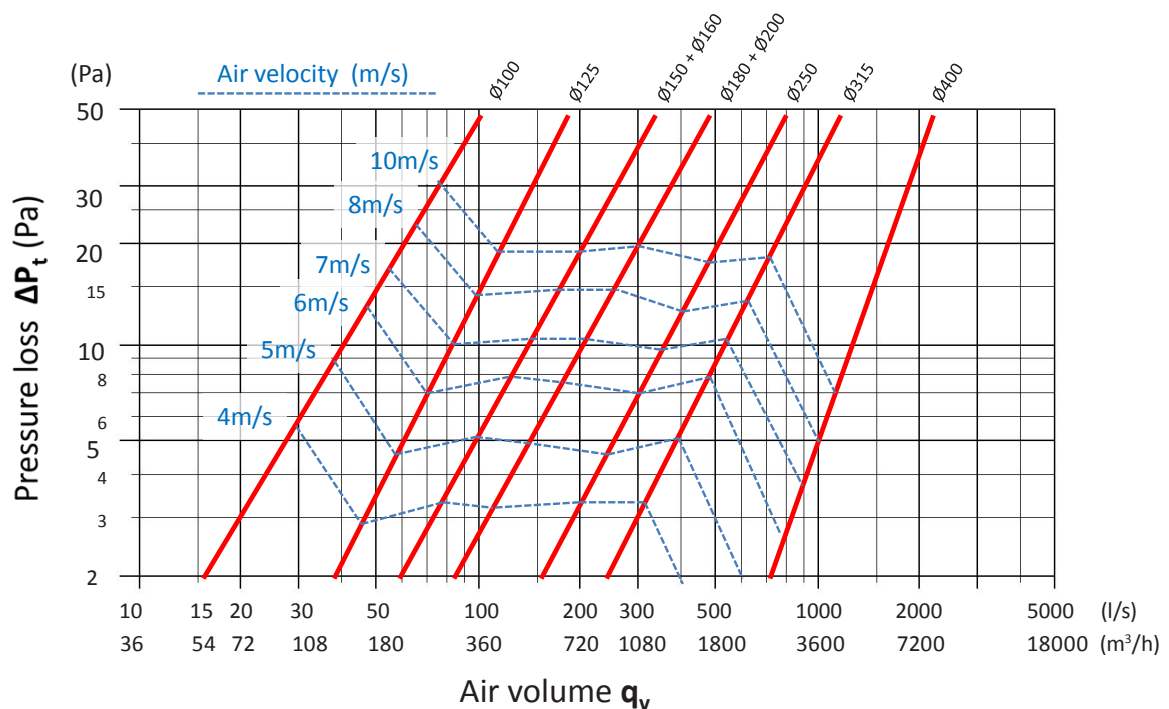



VENTILATION DUCTS & FITTINGS

## Assortment

### **KEN-LOK**

Fittings

Dampers

Silencers

Access doors

Damp proof

Fire dampers

Insulated

### **SPIRALO**

Ventilation hoods

Flexible ducts

Components

Mounting material

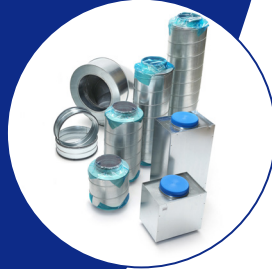
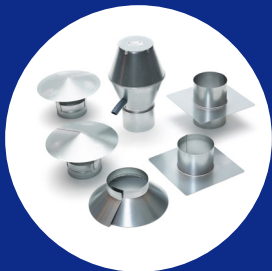
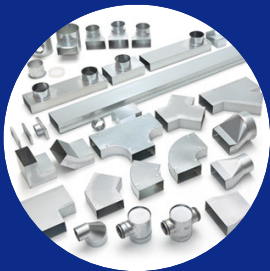
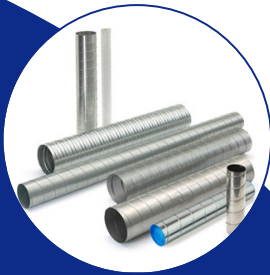

Air Spiralo BV • Lagedijkerweg 15 • 1742 NB Schagen • The Netherlands

T +31 224 210 062 • sales@airspiralo.com • www.airspiralo.com

Member of Air Spiralo Group